

# DENTAL UNIT DIVERSO

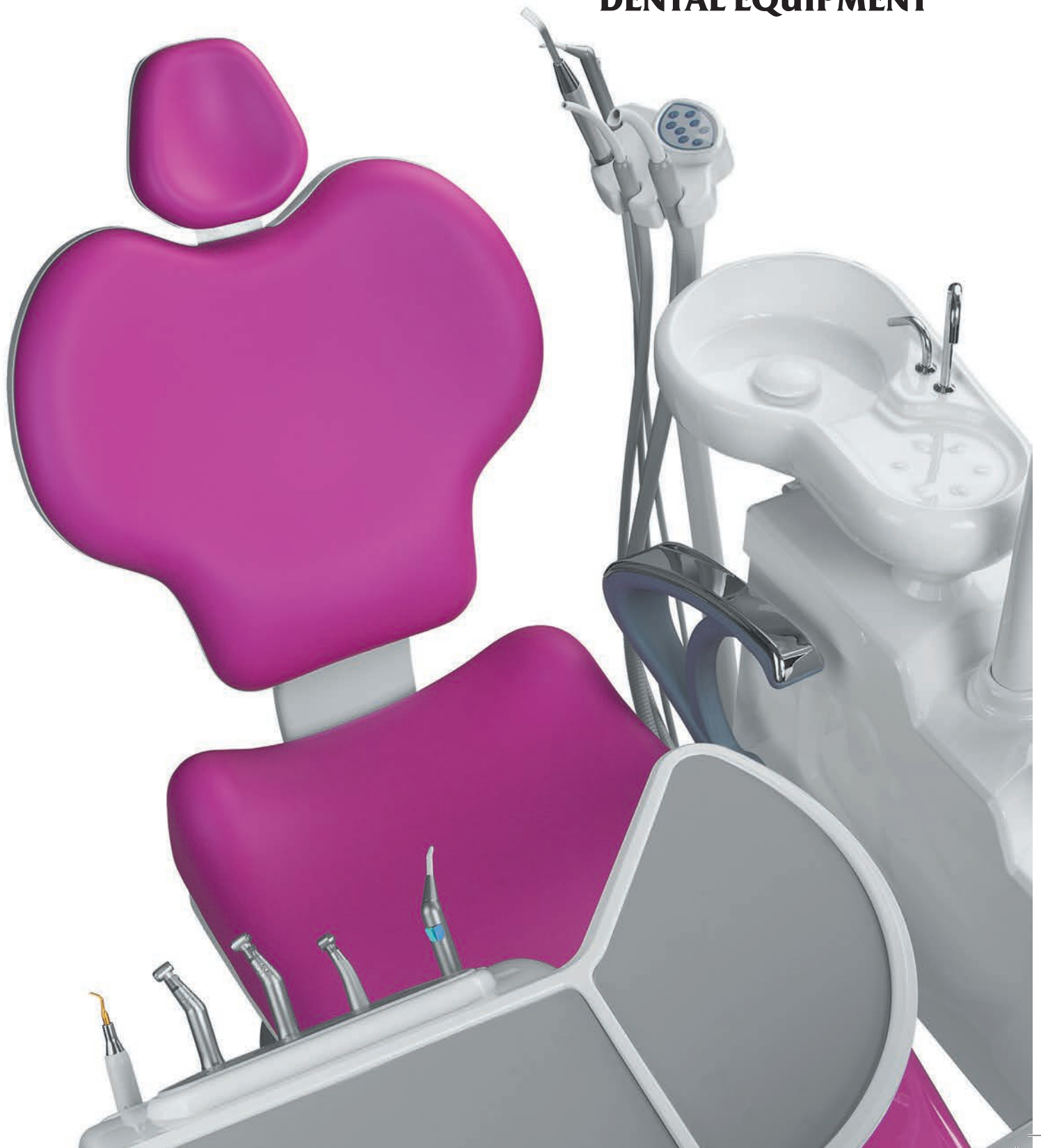

**DENTAL EQUIPMENT**



Designed for you to enjoy while working

# DENTAL UNIT DIVERSO









Optionally scaler, turbine, electrical micromotor features can be added to the tablet's exit.

**Programmed Tablet Control with LCD Display**

In case of using an electric micromotor, the speed of the micromotor can be seen on the screen, it can be increased / decreased, 3 programs you have used frequently can be saved and you can change the direction to right / left.



**4+1 chair programmed panel**

With one button, the chair can come to spitoon position, and after when you press the same button the chair come last position

# DENTAL UNIT DIVERSO S

For you and for your Patient  
Improved with Unit Disinfection system





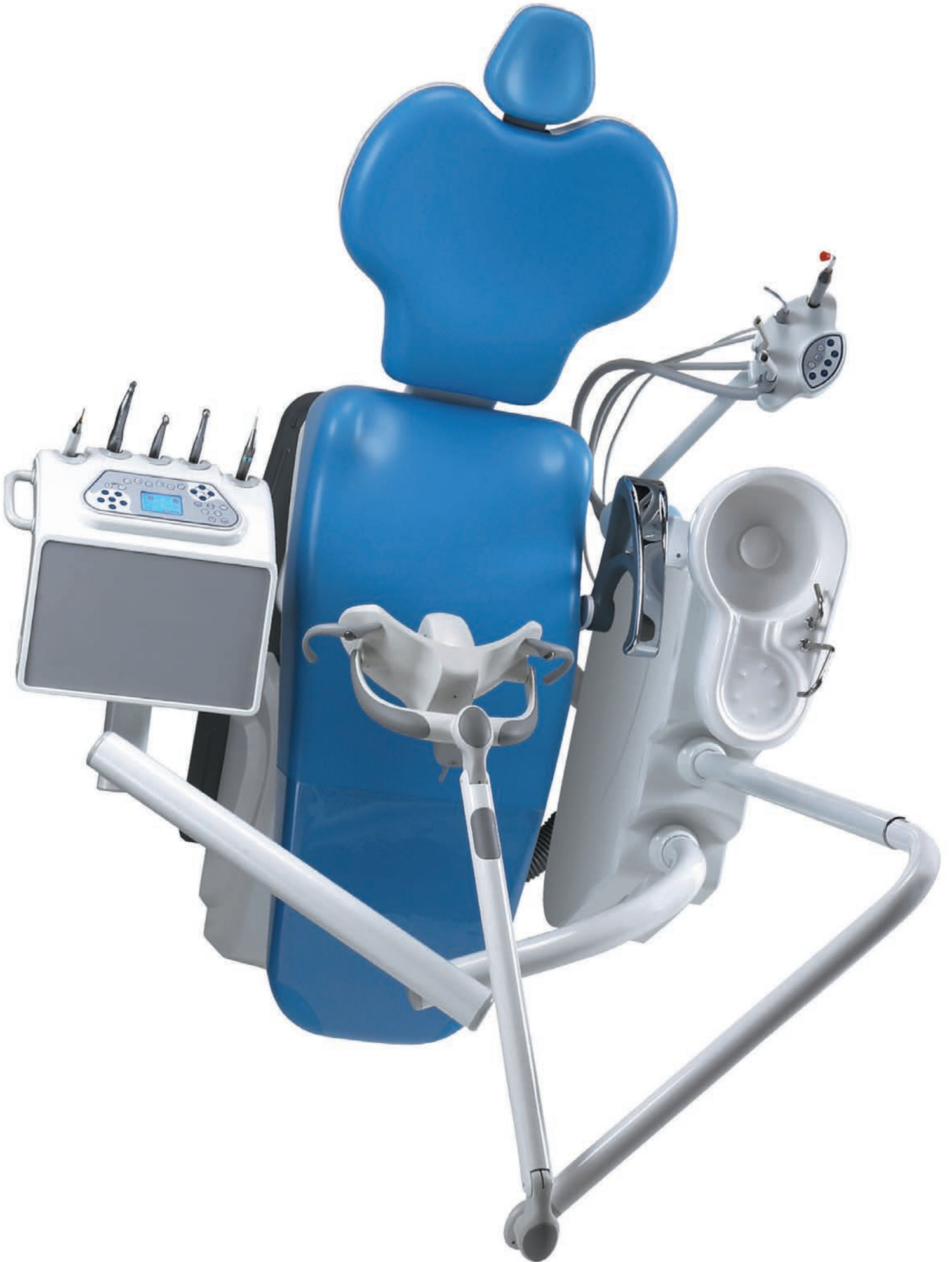





With an easy to use interface, with one button it is possible ; cuspidor glass water on /off, selection of water tank or city water or unit disinfection system, working with water or without, peristaltic pump solution speed, chair movement control and chair movement programm.







Optionally in addition to 2 surgical aspiration exit , polymerization , second syringe or other handpieces can be added.



Standard assistant's arm



Useful for hygiene and less sensitive against disinfection solutions, it can be removed easily and autoclavable.



Inox cuspidor and glasses pipes make it possible use them easily without having problem such a rust or peeling.



A new way of working  
with Multifunctional TOUCH panel

# DENTAL UNIT DIVERSO





JUST IMAGINE,

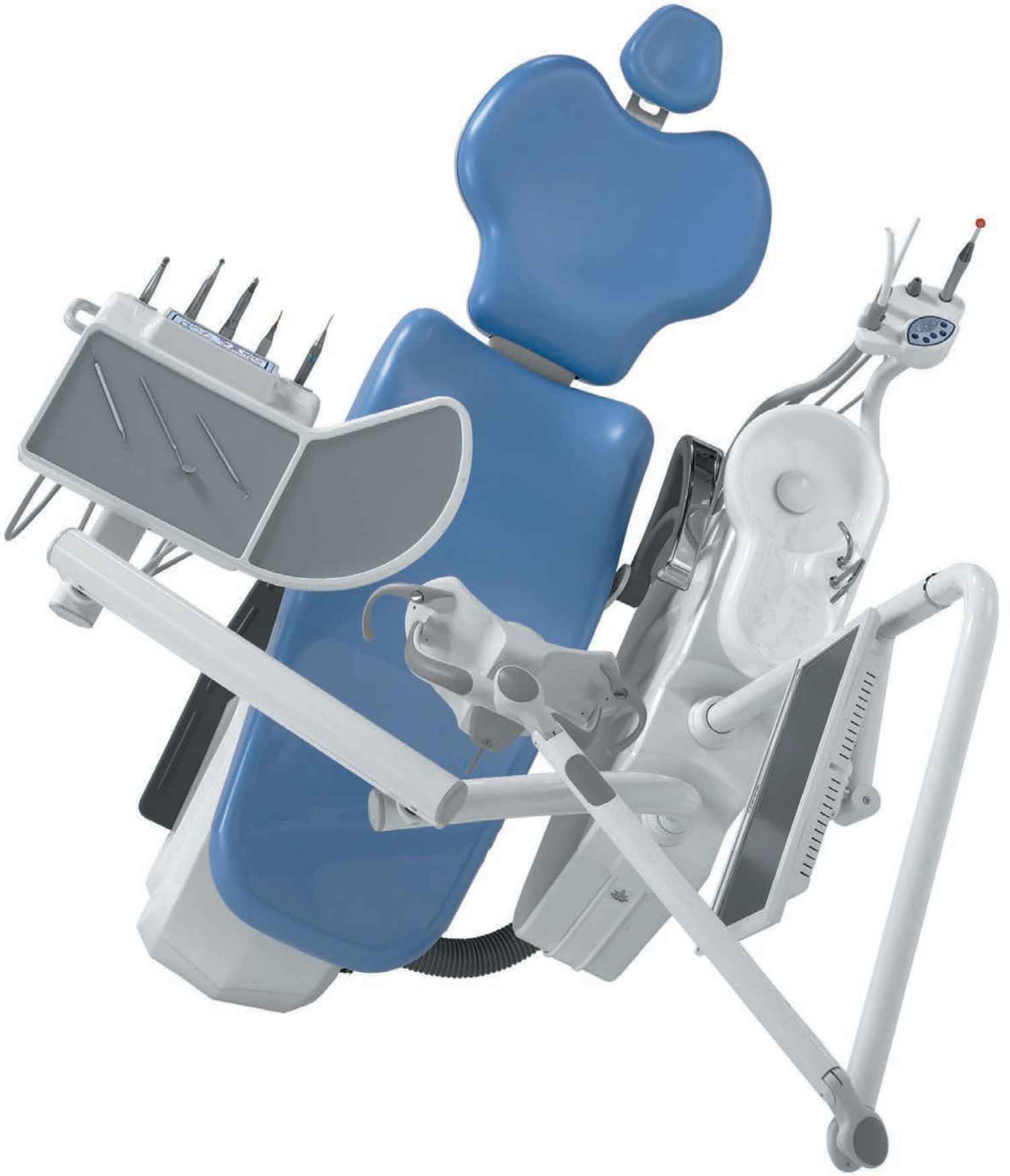



WE REALISE YOUR DREAMS

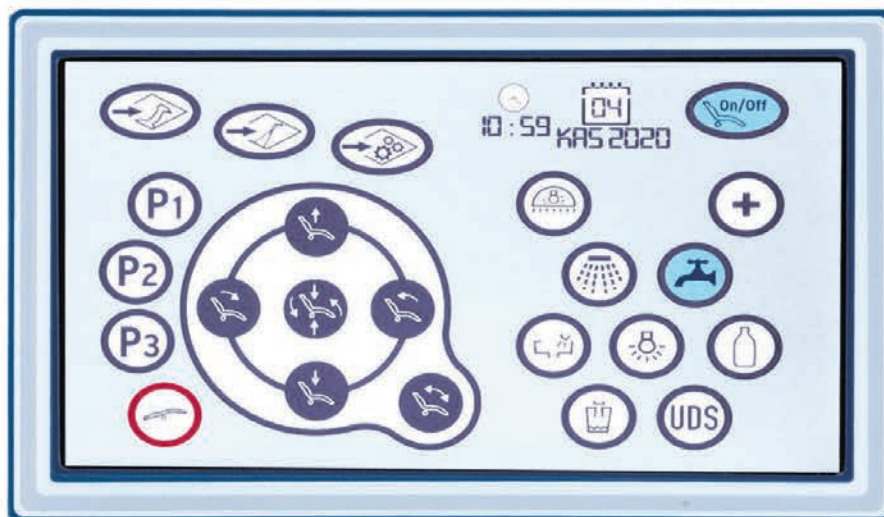

Control all function from  
7 inch touch screen



Operation lamp adjustment, selection of water tank or city water, Fiber optic on / off  
Chair program and all movement, chair movement activation / disactivation  
Unit disinfection system selection, micromotor selection, scaler, control of cuspidor and class with timer



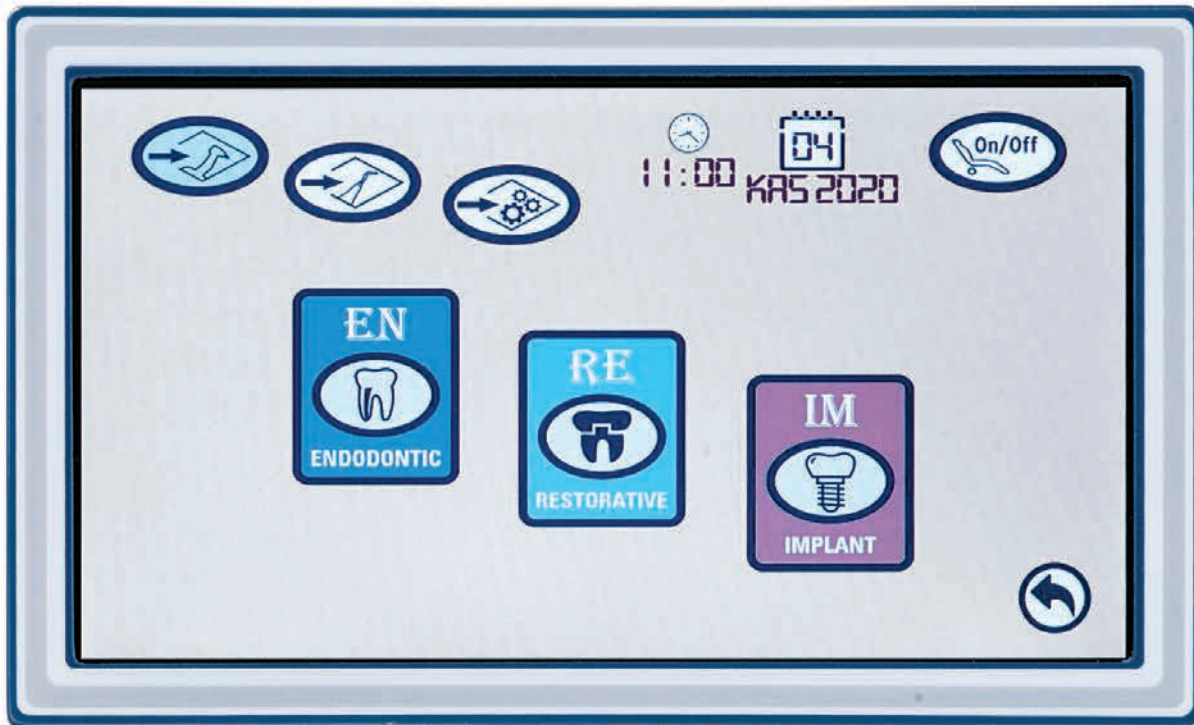

### RIGHT OF CHOICE

From micromotor menu, you can select endodontic, restorative and implant micromotor. Correcta Unit makes it possible to use double type micromotor at the same unit.

### ENDODONTIC SCREEN

A new user friendly screen allows you control of speed, torque, light intensity, liquid level of peristaltic pump, contraangle selection, micromotor 3 program speed, micromotor 3 program mode ( auto reverse, normal mode, auto forward )

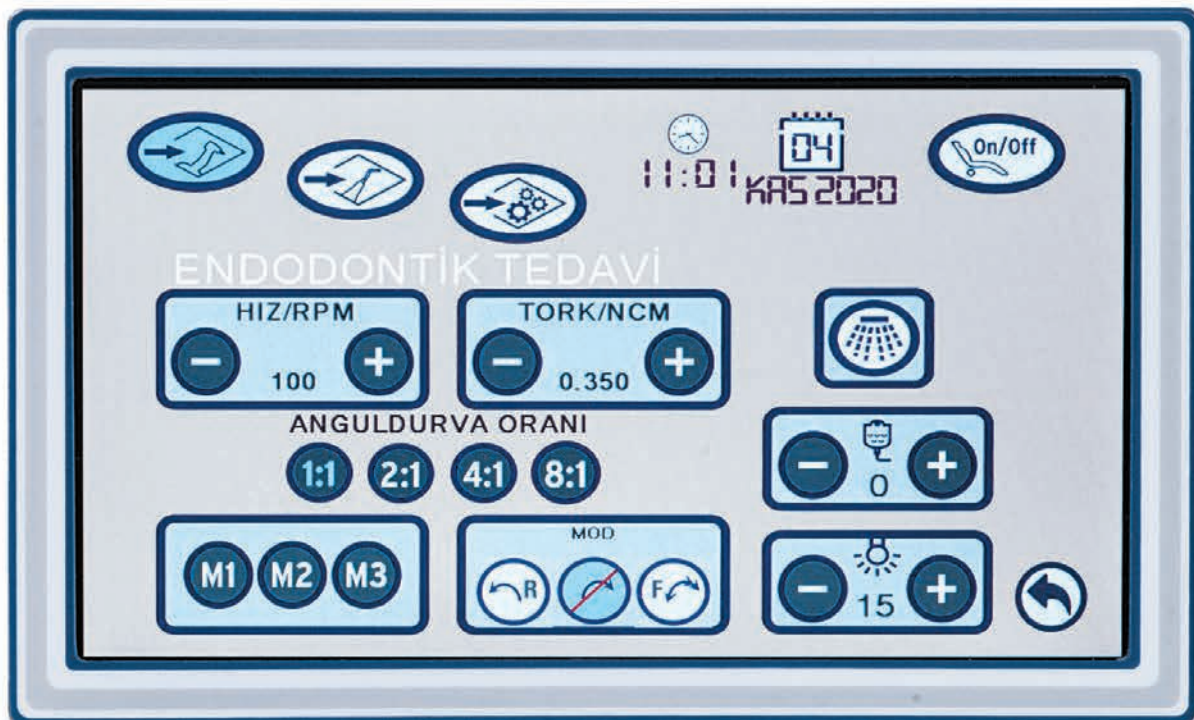

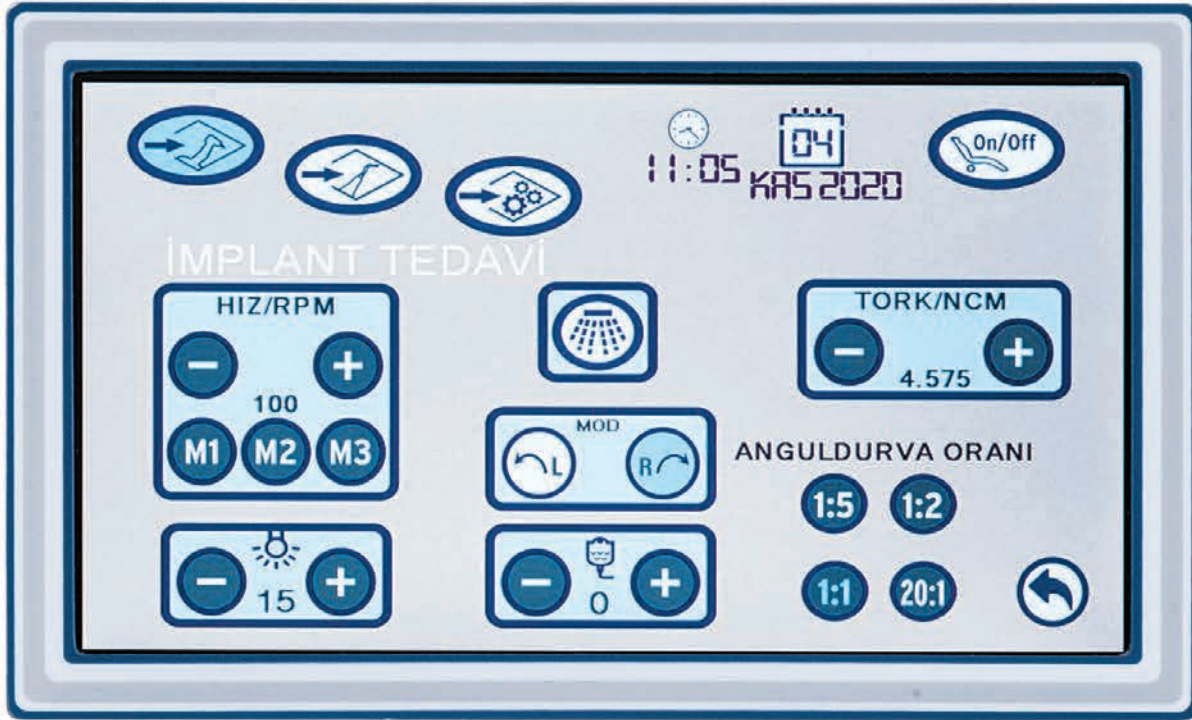

#### IMPLANT

Touch panel allows you control in addition to speed , also torque , light intensity, micromotor 3 program speed, direction of the micromotor ( left and right ) liquid level of peristaltic pump, contraangle selection, micromotor 3 program speed, In addition, with one button it is possible turn on / off water

#### RESTORATIVE

The micromotor speed can be controlled between 1000 -40.000 rpm, you can select the contraangle and control , light intensity, liquid level of peristaltic pump, contraangle selection, micromotor 3 program speed, direction of the micromotor ( left and right )

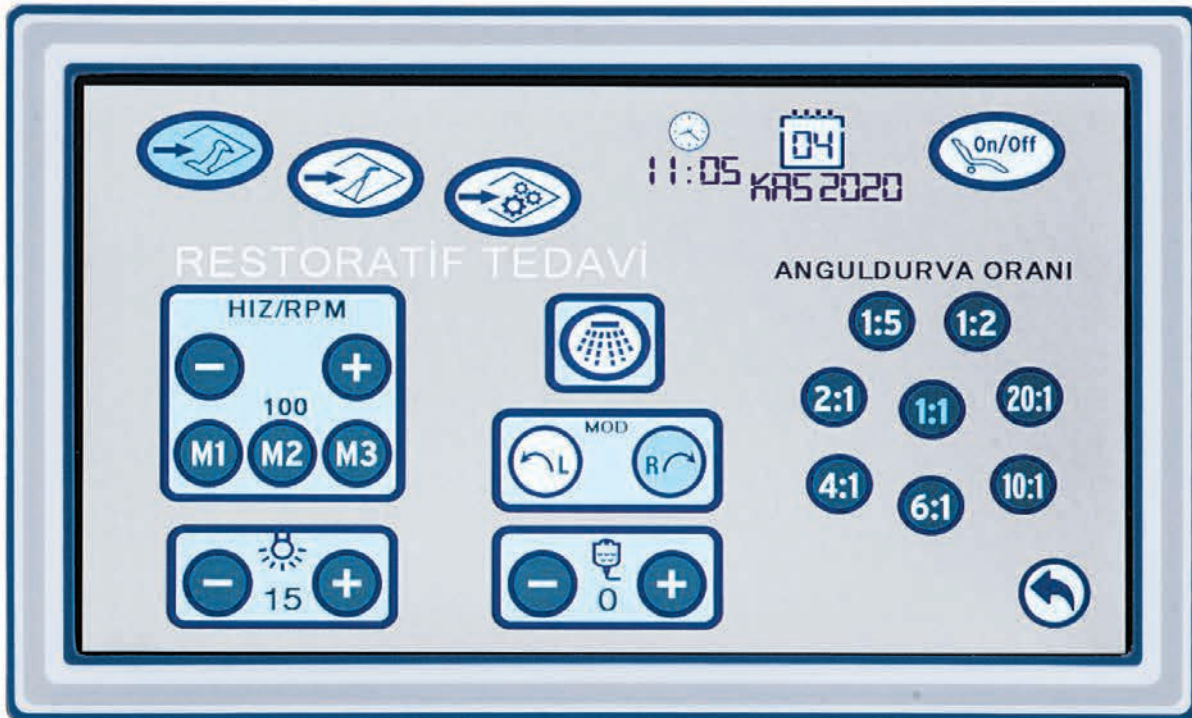

## SCALER SCREEN

Programmed Endo, Perio, Scaler 3 program allows you to make proper tooth cleaning and with one button it is possible to turn on/off the water

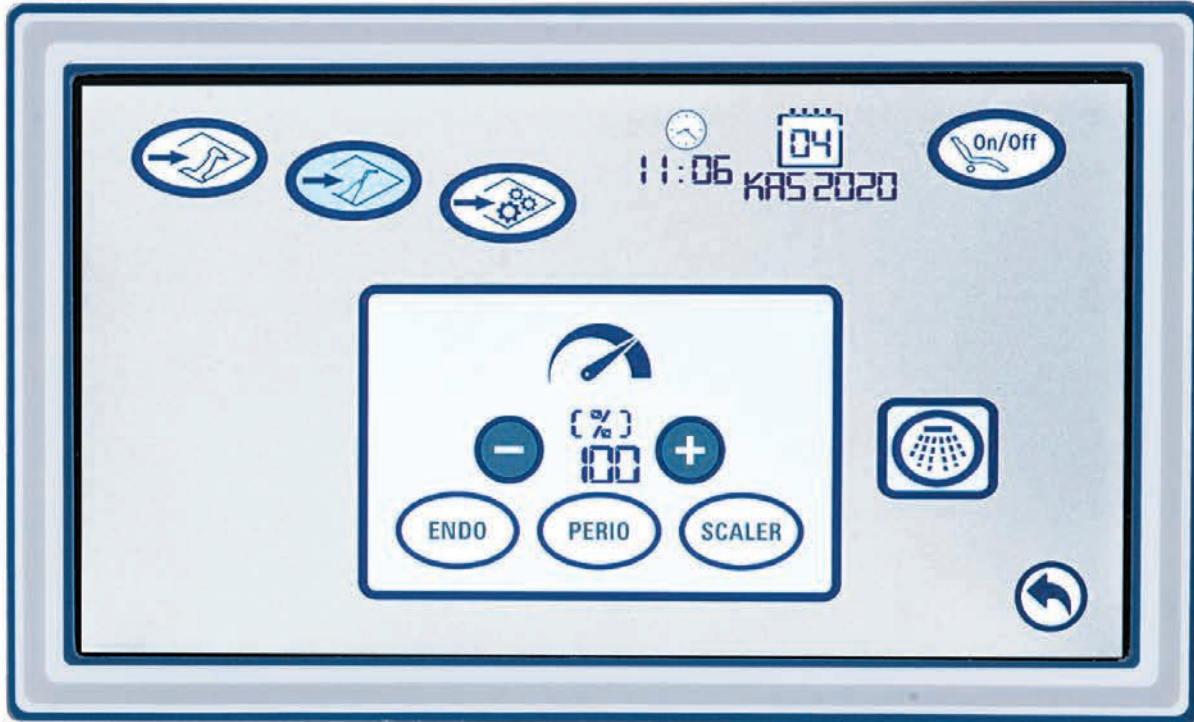

Italien **Gcomm**  
operation lamp  
22.000 Lux



## Edi

Italien Faro Edi operation lamp  
( halogen ) with max 24.000 Lux ,  
light intensity can be regulated  
and handles are autoclavable.



## Alya

Italien Faro special patented  
3d movement and has  
%97 color temperature ;  
max 50.000 Lux



## Maia

Italien Faro 3.000-30.000 lux  
and handles are autoclavable.



## IMPROVEMENT



## STEP BY STEP IN HYGIENE



Aspiration filters and tubes are easy to remove and autoclavable.



## UNIT DISINFECTION SYSTEM

With %3 hydrogen peroxide , this system make it possible the cleaning of the whole way to glasses and tablet exits.



In case of need of city water, you can just select and continue to your treatment.



**Peristaltic Pump**  
Provide sterile irrigation liquid  
to micromotors  
for surgical operation.



Silicon cover  
are autoclavable.



For a hygienic working environment  
all outlet hoses  
easily removed  
It can be sterilized in autoclave.





**Narrow or wide Backrest** depends on your working habits



Comfort of Patient are important ;  
but our design offer for also dentist  
the best comfortable position

**Trandelenburg movement** can be added to the chair movement,  
standart or with programed version.



Movable **right arm** can be added optionally  
to have more comfort for your patients.

Control that can be fixed to the base of the unit,  
gives user possibility to change chair movement  
without using hands.





### Multi axis movement

Freedom in the working position  
Left right, in every angle ;  
possibility to fix the headrest.



### Double Movement Headrest

With double movement dentist can adjust easily  
most comfortable position for patient.  
For children adjust down,  
for wheelchair patient easy in reverse position.





**Multifunction**  
chrome based foot rest  
**dentist stool**  
with automatic brake



The backrest part is movable up/ down  
and forward / backward.  
It is possible to fix in desired position.

Specially designed  
for working ergonomically;  
**saddle type dentist stool**  
with chrome foot rest  
and automatic brake.



**Dentist stool**  
with chrome foot rest



Electrical pneumatical pedal  
with chair movement control  
( chip blower system)



Pneumatic pedal Chip Blower system,  
with water spray control



Soft upholstery option

**What is your COLOR of life?**

Wide range selection of colors suitable for your working environment



Correcta Unit Dimensions

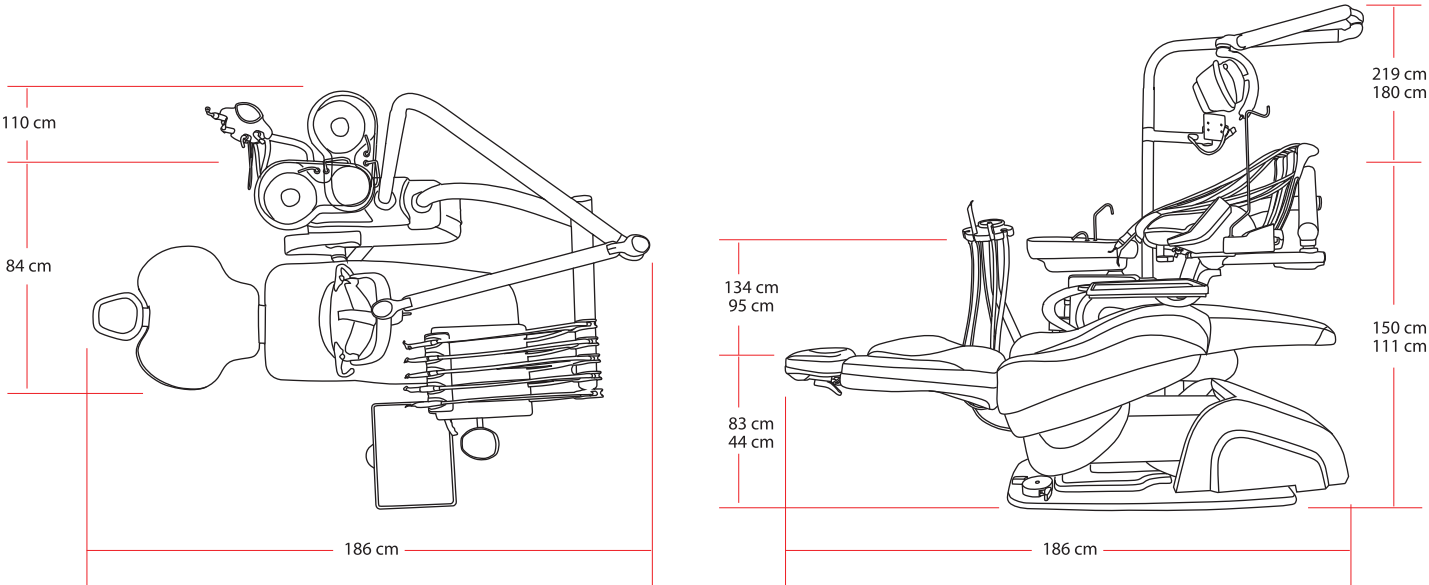

YOUR HEALTH IS IMPORTANT FOR US  
Therefore we give importance  
hygiene with Correcta Unit.



EN ISO 9001  
EN ISO 13485  
MDD 94/42/EEC  
CE 1984



**DENTAL EQUIPMENT**

İnönü Mahallesi Çayır Sokak No:43 Harbiye-Şişli-İstanbul/ TURKEY

+90 212 233 7837 +90 212 231 7277 satis@tekmil.com.tr  
230 4986 +90 545 96367 26 www.tekmil.com.tr