

DENTAL UNIT CORRECTA PLUS

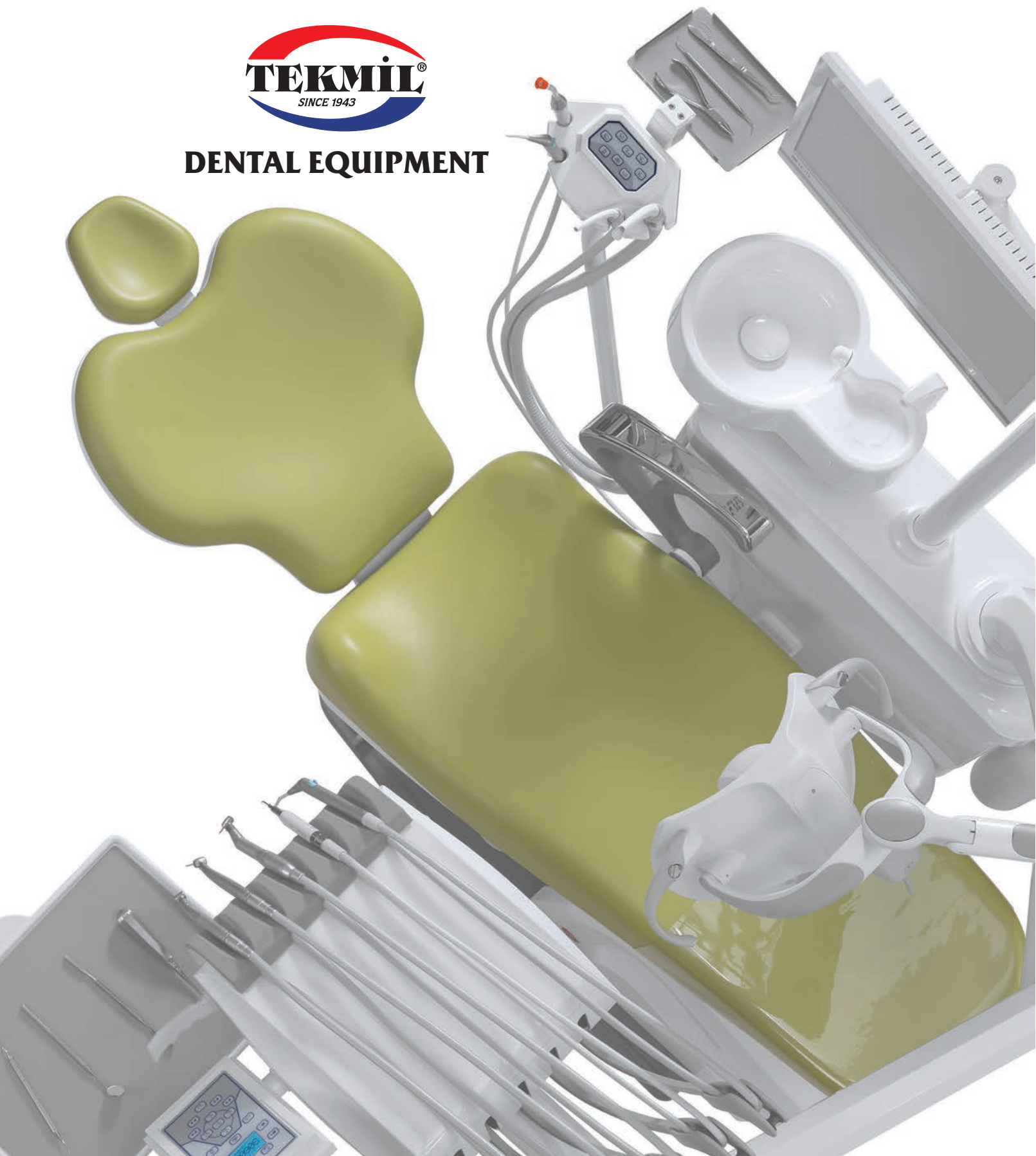

DENTAL EQUIPMENT



Designed for you to enjoy while working

DENTAL UNIT CORRECTA PLUS



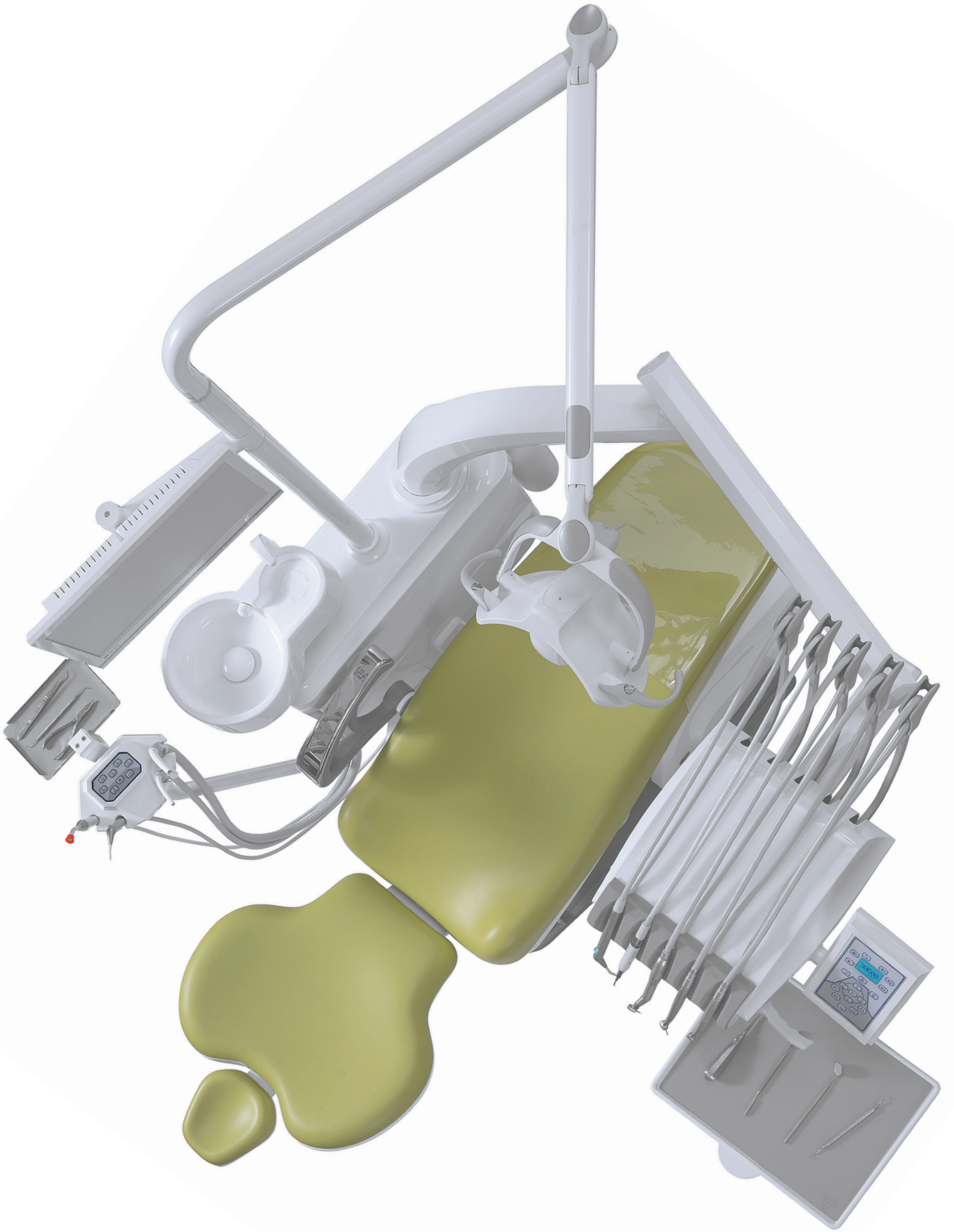



Optionally scaler, turbine, electrical micromotor features can be added to the tablet's exit.

Thanks to its ergonomics without the need for a stop system, provides comfortable use all day long.



Micromotor screen, Programmed Tablet Controller

In case of using an electric micromotor, the speed of the micromotor can be seen on the screen, can be increased / decreased, you use frequently 3 programs can be saved and you can change the direction.

4 + 1 Seat programmed panel thanks to the preset program With one button it comes to the spitting position, with one button after operation returns to its last seat position.

You Will Be Happy While Working

DENTAL UNIT CORRECTA PLUS S

For the health of you and your patients
The unit was renewed with a Disinfectant System.

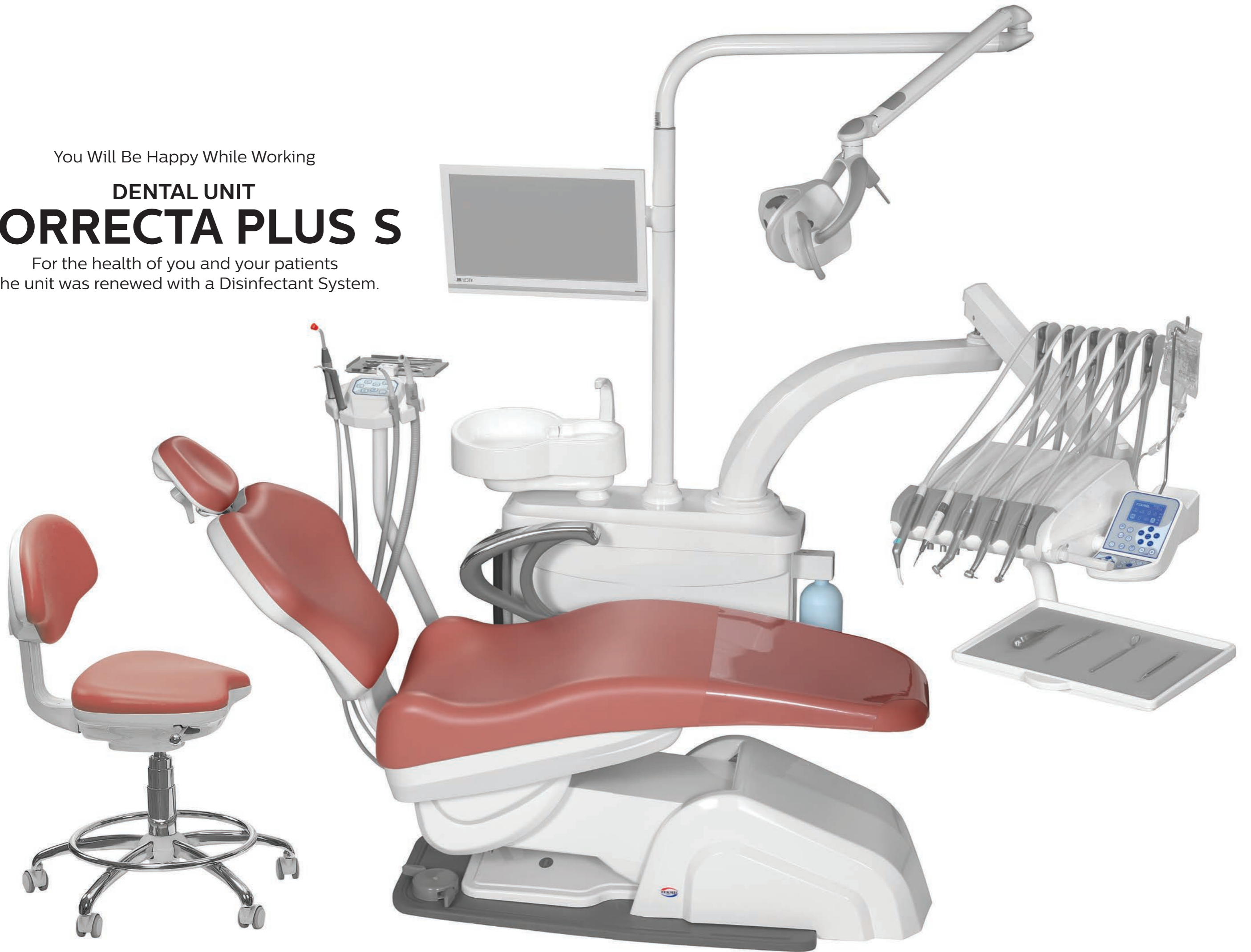

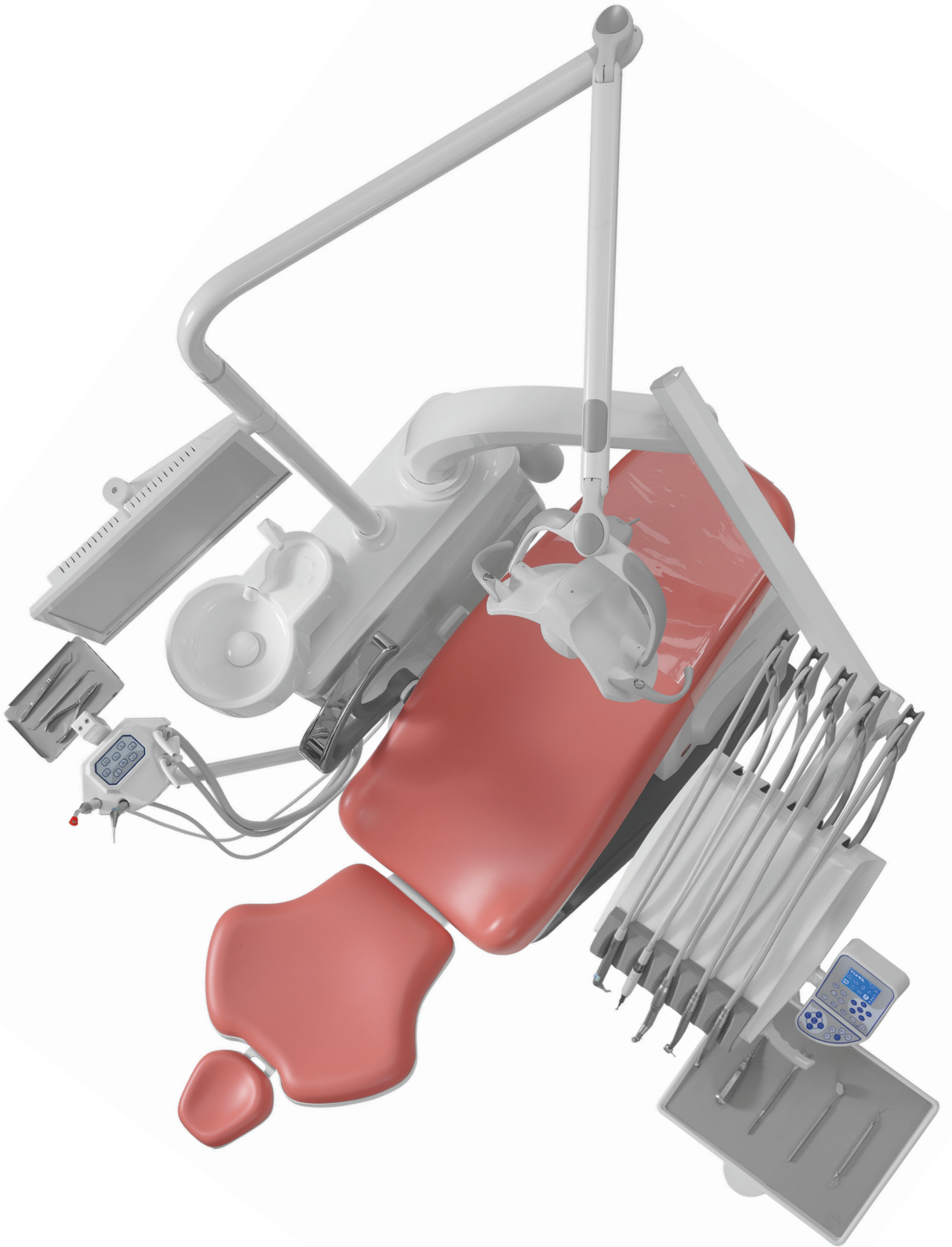



With an easy to use interface, with one button it is possible ; cuspidor glass water on /off, selection of water tank or city water or unit disinfection system, working with water or without, peristaltic pump solution speed, chair movement control and chair movement programm.





Optionally in addition to 2 surgical aspiration exit , polymerization , second syringe or other handpieces can be added.



Silicone cover in the assistant tray is autoclavable.



Cuspidor Body, glass and cup holder outlets Are made of hygienic ceramic. It can be easily disassembled and cleaned.

DENTAL UNIT
CORRECTA PLUS TOUCH

A new way of working
with Multifunctional TOUCH panel



JUST IMAGINE,

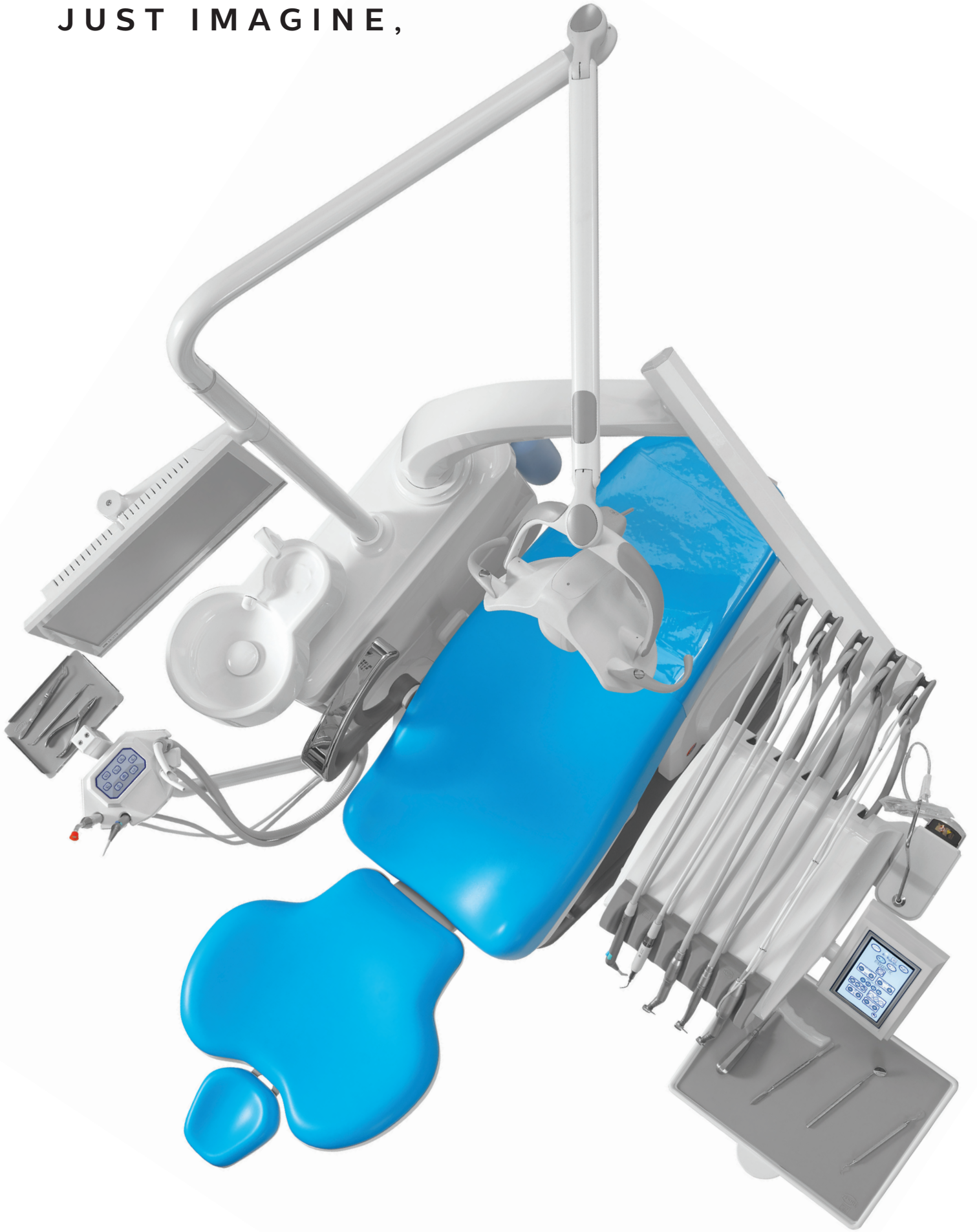



WE REALISE YOUR DREAMS

Control all function from
7 inch touch screen



Operation lamp adjustment,
selection of water tank or city water,
Fiber optic on / off
Chair program and all movement,
chair movement activation / disactivation
Unit disinfection system selection,
micromotor selection, scaler,
control of cuspidor and class with timer

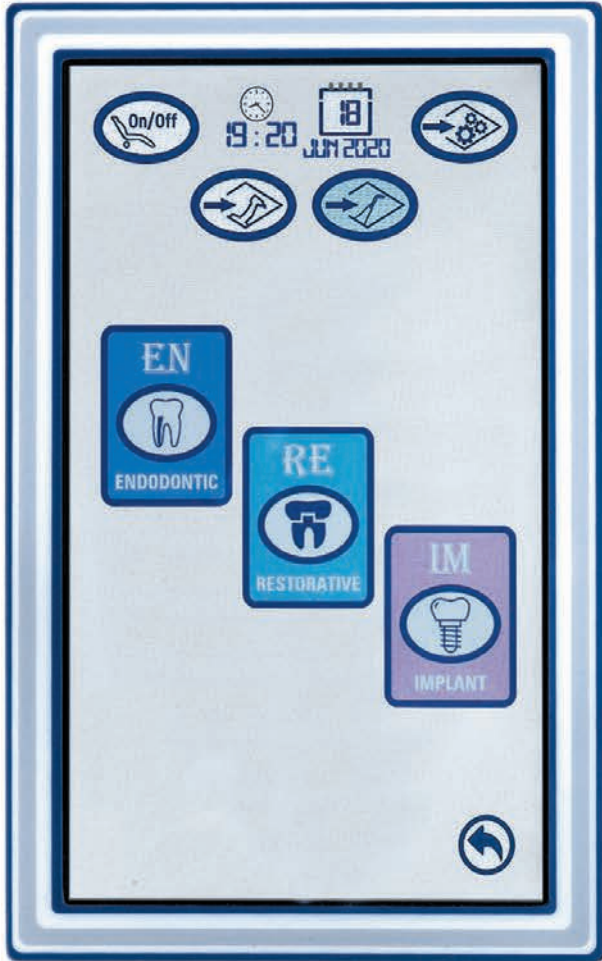

RIGHT OF CHOICE

From micromotor menu, you can select endodontic, restorative and implant micromotor Correcta Unit make it possible to use double type micromotor at the same unit.

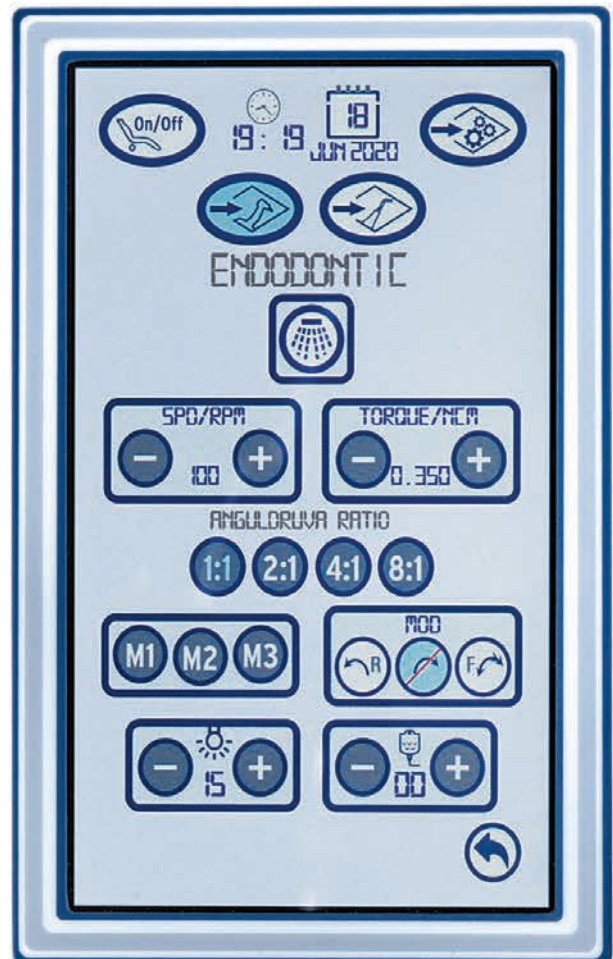

ENDODONTIC SCREEN

A new user friendly screen allows you control of speed, torque, light intensity, liquid level of peristaltic pump, contraangle selection, micromotor 3 program speed, micromotor 3 program mode (auto reverse,normal mode, auto forward)

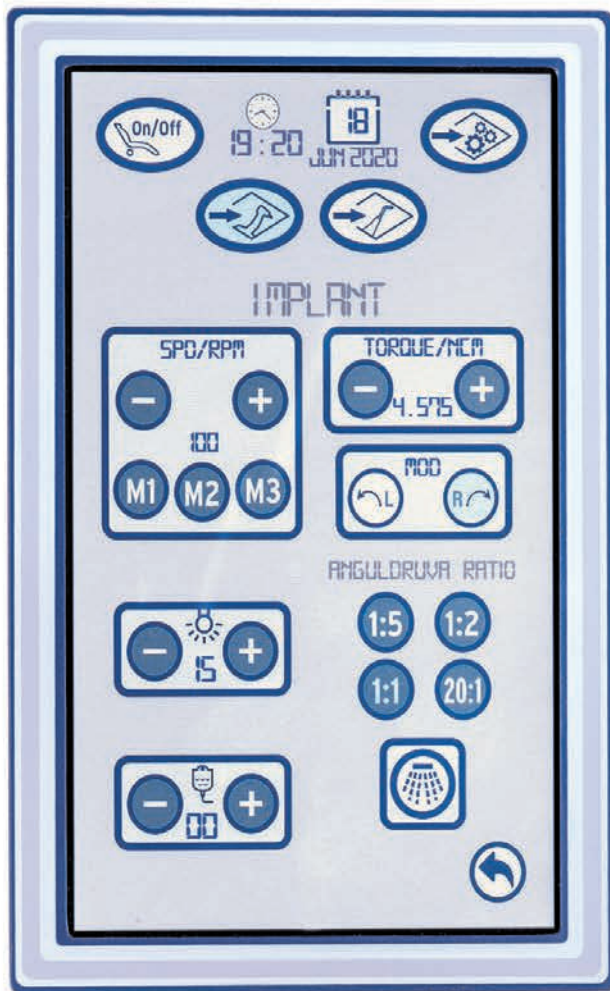

IMPLANT

Touch panel allows you control in addition to speed , also torque , light intensity, micromotor 3 program speed, direction of the micromotor (left and right) liquid level of peristaltic pump, contraangle selection, In addition, with one button it is possible turn on / off water

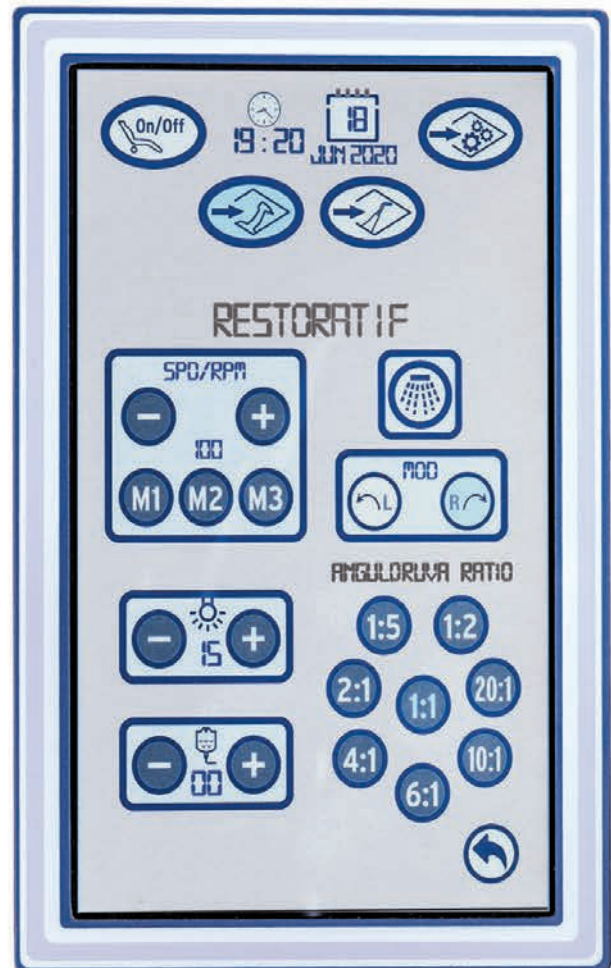

RESTORATIVE

The micromotor speed can be controlled between 1000 -40.000 rpm, you can select the contraangle and control , light intensity, liquid level of peristaltic pump, contraangle selection, micromotor 3 program speed, direction of the micromotor (left and right)



SCALER SCREEN

Programmed Endo, Perio, Scaler 3 program allows you to make proper tooth cleaning and with one button it is possible to turn on/off the water

Italien **Gcomm**
operation lamp
22.000 Lux



Edi

Italien Faro Edi operation lamp (halogen) with max 24.000 Lux , light intensity can be regulated and handles are autoclavable.



Alya

yellow and white light option,
4 different celvin mod for different operation
3rd axis movement flexibility
50.000 Lux , aliminium new arm



Maia

Italien Faro 3.000-30.000 lux
and handles are autoclavable.



IMPROVEMENT



UNIT DISINFECTION SYSTEM
With %3 hydrogen peroxide , this system make it possible the cleaning of the whole way to glasses and tablet's exits.

STEP BY STEP IN HYGIENE



Aspiration filters and tubes are easy to remove and autoclavable.



In case of need of city water, you can just select and continue to your treatment.

Tablet arm up-down movement is provided by the touch sensor on the handle. When left in the desired position, the tablet level remains constant.



Silicon covers are autoclavable.

Magnetical tool handle place, easy to remove and easy to clean.





PERISTALTIC PUMP

Provide sterile irrigation liquid to micromotors for surgical operation.



Thanks to the new tray added to the assistant arm, you can easily put your tools in the tray and continue your work. The silicone cover inside the tray can be autoclavable.

Thanks to the handpiece holder we have produced it to make the UDS unit disinfectant system more practical, you can place your handpieces in their housing and press the UDS button on the tablet. The silicone handpiece holder can be autoclaved.







Narrow or wide Backrest depends on your working habits



Comfort of Patient are important ;
but our design offer for also dentist
the best comfortable position

Trandelenburg movement can be added to the chair movement,
standart or with programmed version.



Movable **right arm** can be added optionally
to have more comfort for your patients.

Control that can be fixed to the base of the unit,
gives user possibility to change chair movement
without using hands.





Multi axis movement

Freedom in the working position
Left right, in every angle ;
possibility to fix the headrest.



Double Movement Headrest

With double movement dentist can
adjust easily most comfortable
position for patient.
For children adjust down,
for wheelchair patient
easy in reverse position.



Thanks to the safety system under
the assistant's arm,
any possible sticking is prevented.



The safety system
on the back of the patient chair
ensures your safety.



Soft upholstery option

What is your COLOR of life?

Wide range selection of colors suitable for your working environment



Multifunction
chrome based foot rest
dentist stool
with automatic brake



The backrest part is movable up/ down
and forward / backward.
It is possible to fix in desired position.

Specially designed
for working ergonomics;
saddle type dentist stool
with chrome foot rest
and automatic brake.



Dentist stool
with chrome foot rest



Electrical pneumatical pedal
with chair movement control
(chip blower system)



Pneumatic pedal Chip Blower system,
with water spray control

Correcta Plus Unit Dimensions

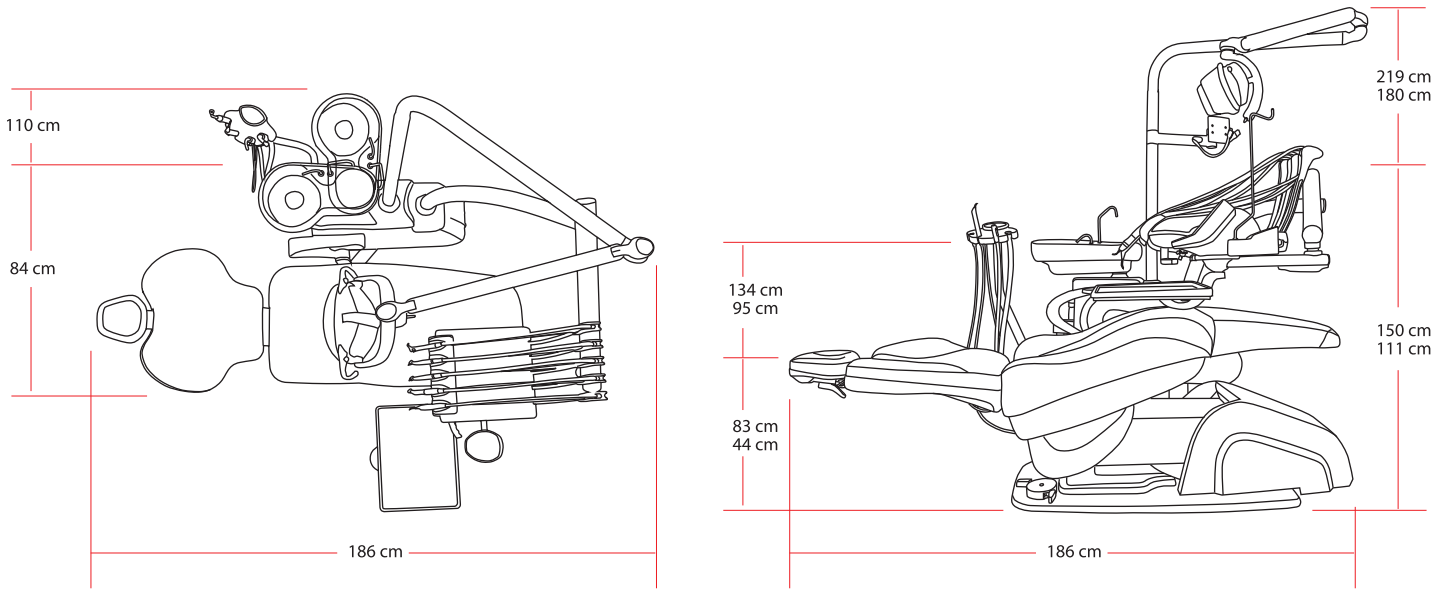



YOUR HEALTH IS IMPORTANT FOR US
Therefore we give importance HYGIENE with Correcta Unit.



EN ISO 9001
EN ISO 13485
MDD 94/42/EEC

CE 1984



DIŞ HEKİMLİĞİ CİHAZLARI

📍 İnönü Mahallesi Çayır Sokak No:43 Harbiye-Şişli-İstanbul/TÜRKİYE



+90 212 233 7837



+90 212 231 7277



satis@tekmil.com.tr

+90 212 230 4986



+90 545 96367 26



www.tekmil.com.tr